

CDP 1500/800-BSY+



Approvals / Certificates

Find out about permission details from your D+H Partner.



G 513003



5014068.18001



Article also available with the following permissions under other article numbers. Technical data may deviate.



Technical data

CDP 1500/800-BSY+

Supply	24 V DC / $\pm 15\%$ / 4 A
Duty cycle	30 % (ON: 3 min. / OFF: 7 min.)
Force of pressure	1500 N
Tensile force	1500 N
Nominal locking force *	3000 N
Service life	> 10000 double strokes
Stroke	800 mm
OPEN running speed	6 mm/s
OPEN running speed - SHEV	17.7 mm/s
CLOSED running speed	6 mm/s
Type of protection	IP 32
Emission sound pressure level	LpA \leq 70 dB(A)
Temperature range	-15 °C (-5 °C **) ... +75 °C
Fire resistance	B300 (30 min / 300 °C)
Housing	Aluminium
Surface	Powder-coated
Colour	White aluminium (~ RAL 9006)
Connection	2.5 m silicone cable
W x H x D	807 x 67 x 110 mm
Weight	8.3 kg
Remark	Variable equipment possible
Art. No.	26.600.10

* Depending on the mounting, ** in accordance with VdS 2580

Dimensions

All specifications in mm

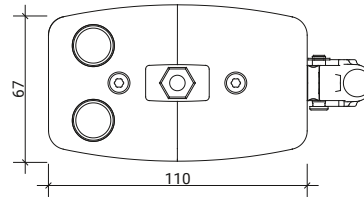
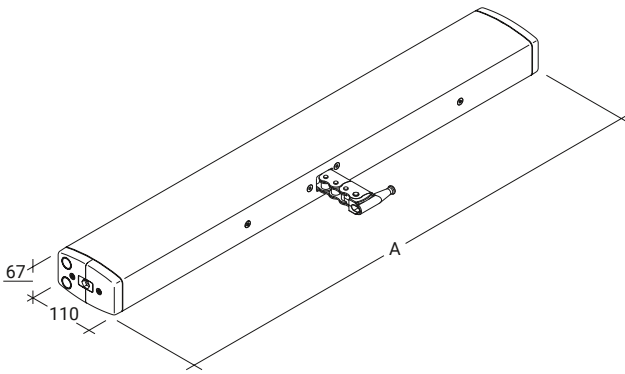

Pressure load diagram

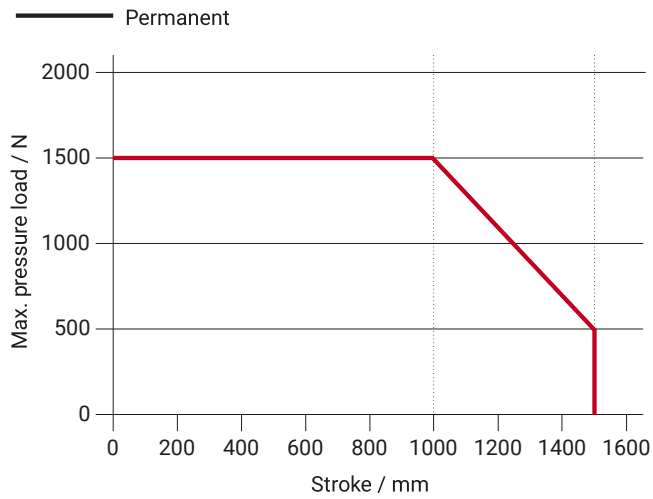

Possible applications

- + Mounted installation
- + Application force
- + Frame mounting
- + Application tension

