

ZA-1000-0500-1-PLP-R

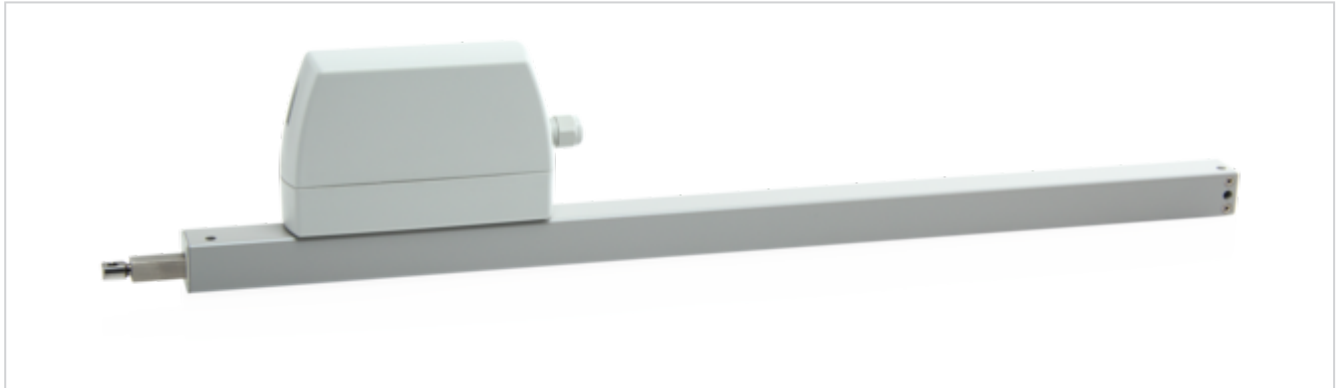

Performance features

- + Can be used for openings for smoke exhaust; D+H Euro SHEV in accordance with EN 12101-2; and for daily ventilation
- + With motor electronics controlled via microprocessor
- + High-speed function (HS) for especially fast opening windows in case of fire (SHEV) (optionally available)
- + Low current consumption thanks to high efficiency
- + Option of cable infeed above and below
- + Drive unit can be changed from left to right
- + Programmable drive functions and different drive parameters
- + Running speed in CLOSED direction decreases to 5 mm/s (passive closing edge protection)
- + Time-controlled reversing when an obstacle is detected in the CLOSED direction (active closing edge protection)

Approvals / Certificates

Find out about permission details from your D+H Partner.



Article also available with the following permissions under other article numbers. Technical data may deviate.



Technical data

ZA-1000-0500-1-PLP-R

Supply	24 V DC / $\pm 15\%$ / 1.2 A
Duty cycle	30 % (ON: 3 min. / OFF: 7 min.)
Force of pressure	1000 N
Tensile force	1000 N
Nominal locking force **	Max. 1400 N (1100 N ***)
Service life	20000 double strokes *
Stroke	500 mm
OPEN running speed	7.1 mm/s
OPEN running speed - SHEV	8 mm/s
CLOSED running speed	7.1 mm/s
Type of protection	IP 65
Emission sound pressure level	LpA \leq 51 dB(A)
Temperature range	-15 °C (-5 °C ***) ... +75 °C
Fire resistance	B300 (30 min / 300 °C)
Housing	Aluminium / Polycarbonate
Surface	Powder-coated
Colour	White aluminium (~ RAL 9006)
Connection	2.5 m silicone cable
Dimension A	662 mm
Weight	1.95 kg
Art. No.	27.005.60

* For vertical use, please consult with D+H Sales!

** Depending on the mounting, *** in accordance with VdS 2580

Dimensions

All specifications in mm



Pressure load diagram

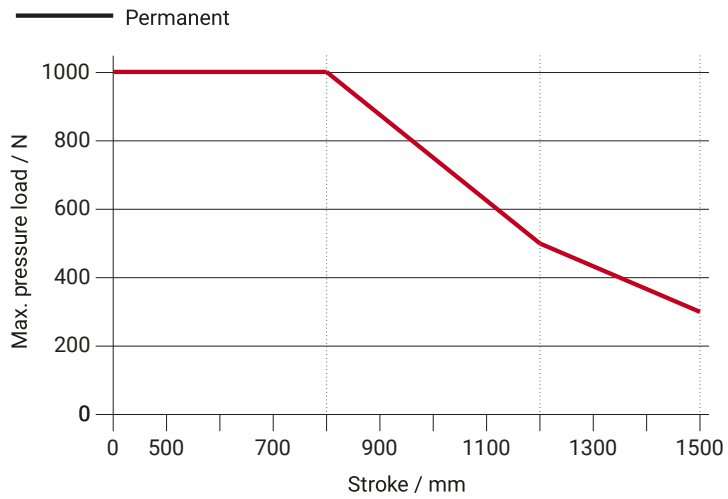

Possible applications

- + Mounted installation
- + Side installation
- + Frame mounting
- + Application force
- + Sash mounting
- + Application tension
- + Installation opposite the hinge

