

VCD 204/350-K (SR)

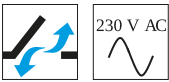

Performance features

- + For façade windows, roof windows and ventilation flaps in conservatories
- + With motor electronics controlled via microprocessor
- + Direct control via 230 V AC
- + Special chain stabilisation and centred chain outlet
- + Option of chain stroke programming via magnet
- + Simple connection via plug connector
- + Programmable drive functions and different drive parameters
- + Running speed in CLOSED direction decreases to 5 mm/s (passive closing edge protection)
- + Time-controlled reversing when an obstacle is detected in the CLOSED direction (active closing edge protection)

Approvals / Certificates

Find out about permission details from your D+H Partner.



5014959.22003

Technical data

VCD 204/350-K (SR)

Supply	230 V AC / +10 % ... -15 % / 50 ... 60 Hz
Performance	10 W / 15 VA
Duty cycle	30 % (ON: 3 min. / OFF: 7 min.)
Force of pressure	200 N
Tensile force	200 N
Nominal locking force **	2000 N
Service life	20000 double strokes *
Stroke	350 mm
OPEN running speed	6 mm/s
CLOSED running speed	6 mm/s
Type of protection	IP 30
Emission sound pressure level	LpA ≤ 46 dB(A)
Temperature range	0 °C ... +60 °C
Housing	Die-cast zinc
Surface	Powder-coated
Colour	Silver (~ RAL 9006)
Connection	2.5 m PVC-cable
W x H x D	480 x 30 x 47 mm
Weight	1.6 kg
Art. No.	25.120.10

* For vertical use, please consult with D+H Sales!

** Depending on the mounting

Dimensions

All specifications in mm

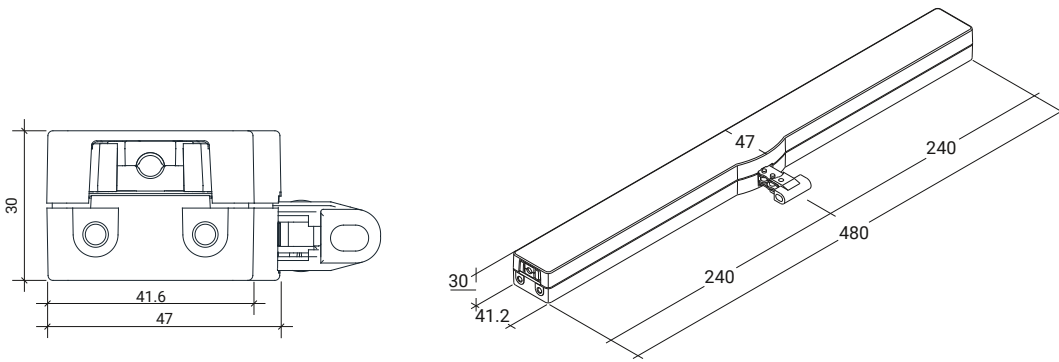

Pressure load diagram

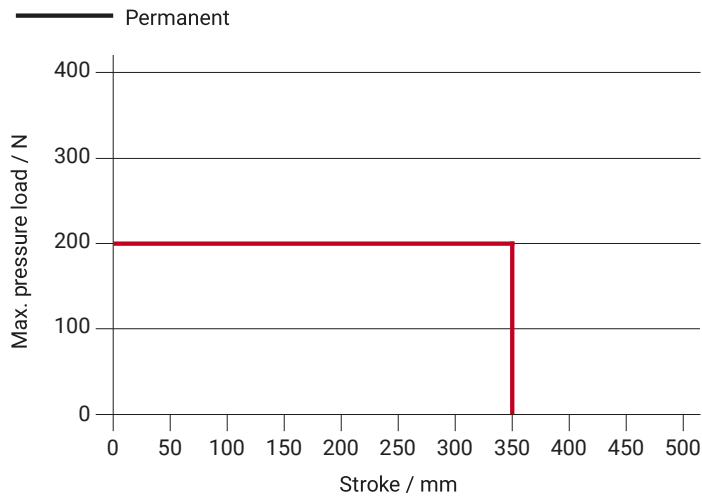

Possible applications

- + Mounted installation
- + Frame mounting
- + Sash mounting
- + Application force
- + Application tension

