

KA 54/600-K



Performance features

- + Can be used for openings for smoke ventilation; D+H Euro SHEV in accordance with EN 12101-2; and for daily natural ventilation
- + With motor electronics controlled via microprocessor
- + Direct control via 230 V AC
- + Special chain stabilisation
- + Relief of pressure on window gasket after closing process
- + Pressure applications up to 700 mm, application tension stroke lengths >1000 mm possible
- + Easy window control via 230 V AC ventilation button
- + Adjustable electronic closing force optimisation
- + Running speed in CLOSED direction decreases to 5 mm/s (passive closing edge protection)
- + Time-controlled reversing when an obstacle is detected in the CLOSED direction (active closing edge protection)

Approvals / Certificates

Find out about permission details from your D+H Partner.



Technical data

KA 54/600-K

Supply	230 V AC / +10 % ... -15 % / 50 Hz
Performance	32 W / 52 VA
Duty cycle	30 % (ON: 3 min. / OFF: 7 min.)
Force of pressure	500 N
Tensile force	500 N
Nominal locking force **	Max. 2600 N (2000 N ***)
Service life	20000 double strokes *
Stroke	600 mm
OPEN running speed	13.3 mm/s
CLOSED running speed	11.8 mm/s
Type of protection	IP 32
Emission sound pressure level	LpA ≤ 70 dB(A)
Temperature range	-15 °C (-5 °C ***) ... +75 °C
Fire resistance	B300 (30 min / 300 °C)
Housing	Aluminium
Surface	Powder-coated
Colour	White aluminium (~ RAL 9006)
Connection	2.5 m silicone cable
Dimension A	685 mm
Dimension B	373 mm
W x H x D	685 x 40 x 59 mm
Weight	2.4 kg
Art. No.	26.002.15

* For vertical use, please consult with D+H Sales!

** Depending on the mounting, *** in accordance with VdS 2580

Dimensions

All specifications in mm

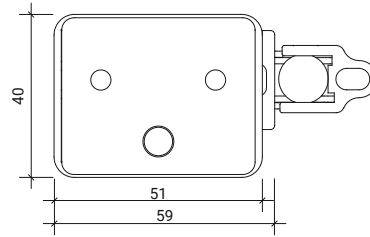
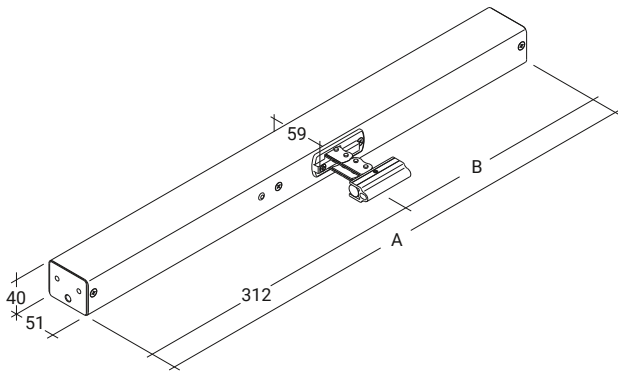

Pressure load diagram

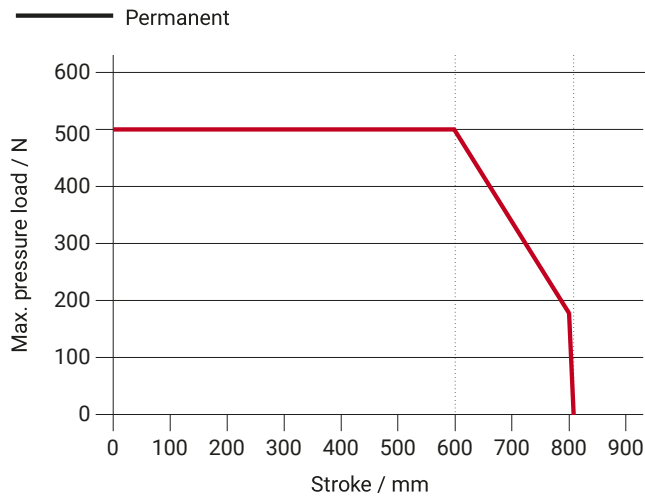

Possible applications

+ Mounted installation

+ Frame mounting

+ Sash mounting

+ Application force

+ Application tension

